



6U8-A/5U8

TRIODE-PENTODE

DESCRIPTION AND RATING

The 6U8-A is a miniature tube which contains a sharp-cutoff pentode and a medium-mu triode in one envelope. Each section has a separate cathode and is electrically independent. The tube is primarily intended for service as a combined triode oscillator and pentode mixer in television and FM receivers, although it is also suitable for a wide variety of general-purpose applications.

Except for heater ratings, the 5U8 is identical to the 6U8-A.

GENERAL

ELECTRICAL

Cathode—Coated Unipotential	5U8	6U8-A	
Heater Voltage, AC or DC	4.7	6.3	Volts
Heater Current	0.6 ± 6%	0.45 ± 6%	Ampere
Heater Warm-up Time*	11	11	Seconds
Direct Interelectrode Capacitances			

	With Shield †	Without Shield	
Pentode Section			
Grid-Number 1 to Plate: (Pg1 to Pp), max.	0.007	0.015	μμf
Input: Pg1 to (h+Pk+Pg2+Pg3+i.s.)	5.0	5.0	μμf
Output: Pp to (h+Pk+Pg2+Pg3+i.s.)	3.5	2.6	μμf
Heater to Cathode: h to (Pk+Pg3+i.s.)	3.0 #	3.0	μμf
Triode Section			
Grid to Plate: (Tg to Tp)	1.8	1.8	μμf
Input: Tg to (Tk+h+Pk+Pg3+i.s.)	2.8	2.8	μμf
Output: Tp to (Tk+h+Pk+Pg3+i.s.)	2.0	1.5	μμf
Heater to Cathode: (h to Tk)	3.0 #	3.0	μμf
Pentode Grid-Number 1 to Triode Plate: (Pg1 to Tp), maximum	0.2	0.2	μμf
Pentode Plate to Triode Plate: (Pp to Tp), maximum	0.02	0.1	μμf

MECHANICAL

Mounting Position—Any
Envelope—T-6½, Glass
Base—E9-1, Small Button 9-Pin

MAXIMUM RATINGS

DESIGN-MAXIMUM VALUES

	Pentode Section	Triode Section	
Plate Voltage	330	330	Volts
Screen Supply Voltage	330	—	Volts
Screen Voltage—See Screen Rating Chart, Page 2			
Positive DC Grid-Number 1 Voltage	0	0	Volts
Plate Dissipation	3.0	2.5	Watts
Screen Dissipation	0.55	—	Watt

(Cont'd on Page 2)

The tubes and arrangements disclosed herein may be covered by patents of General Electric Company or others. Neither the disclosure of any information herein nor the sale of tubes by General Electric Company conveys any license under patent claims covering combinations of tubes with other devices or elements. In the absence of an express written agreement to the contrary, General Electric Company assumes no liability for patent infringement arising out of any use of the tubes with other devices or elements by any purchaser of tubes or others.

BASING DIAGRAM

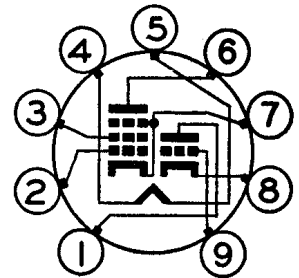

EIA 9AE

TERMINAL CONNECTIONS

- Pin 1—Triode Plate
- Pin 2—Pentode Grid Number 1
- Pin 3—Pentode Grid Number 2 (Screen)
- Pin 4—Heater
- Pin 5—Heater
- Pin 6—Pentode Plate
- Pin 7—Pentode Cathode, Grid Number 3, and Internal Shield
- Pin 8—Triode Cathode
- Pin 9—Triode Grid

PHYSICAL DIMENSIONS

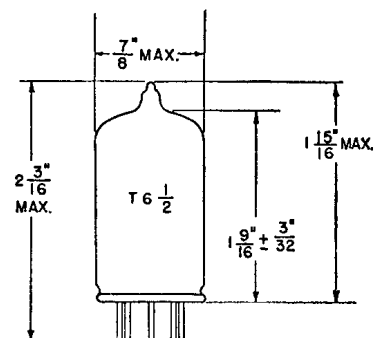

EIA 6-2

GENERAL ELECTRIC

Supersedes ET-T1270 dated 3-56

MAXIMUM RATINGS (Cont'd)

	Pentode Section	Triode Section	
Heater-Cathode Voltage			
Heater Positive with Respect to Cathode			
DC Component	100	100	Volts
Total DC and Peak	200	200	Volts
Heater Negative with Respect to Cathode			
Total DC and Peak	200	200	Volts
Grid-Number 1 Circuit Resistance			
With Fixed Bias	0.5	—	Megohm
With Cathode Bias	1.0	—	Megohm

Design-Maximum ratings are limiting values of operating and environmental conditions applicable to a bogey tube of a specified type as defined by its published data, and should not be exceeded under the worst probable conditions.

These values are chosen by the tube manufacturer to provide acceptable serviceability of the tube, taking responsibility for the effects of changes in operating conditions due to variations in the characteristics of the tube under consideration.

The equipment manufacturer should design so that initially and throughout life no design-maximum value for the intended service is exceeded with a bogey tube under the worst probable operating conditions with respect to supply-voltage variation, equipment component variation, variation in characteristics of all other tubes in the equipment, equipment control adjustment, load variation, signal variation, and environmental conditions.

CHARACTERISTICS AND TYPICAL OPERATION

CLASS A₁ AMPLIFIER

	Pentode Section	Triode Section	
Plate Voltage	100	125	Volts
Screen Voltage	70	110	Volts
Grid-Number 1 Voltage	0	-1.0	Volt
Amplification Factor	—	—	40
Plate Resistance, approximate	—	200,000	5300 Ohms
Transconductance	5500	5000	7500 Micromhos
Plate Current	—	9.5	13.5 Milliamperes
Screen Current	—	3.5	— Milliamperes
Grid-Number 1 Voltage, approximate			
I _b = 20 Microamperes	—	-8	-9 Volts

* The time required for the voltage across the heater to reach 80 percent of its rated value after applying 4 times rated heater voltage to a circuit consisting of the tube heater in series with a resistance equal to 3 times the rated heater voltage divided by the rated heater current.

† With external shield (EIA 315) connected to pin 4 unless otherwise indicated.

With external shield (EIA 315) connected to pin 6.

SCREEN RATING CHART

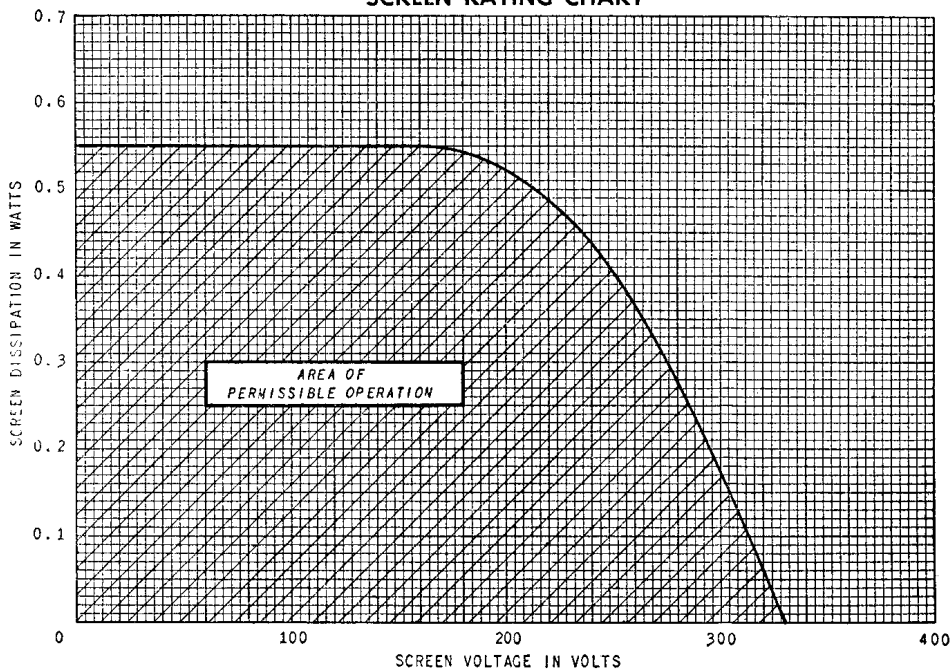

AVERAGE PLATE CHARACTERISTICS
 PENTODE SECTION

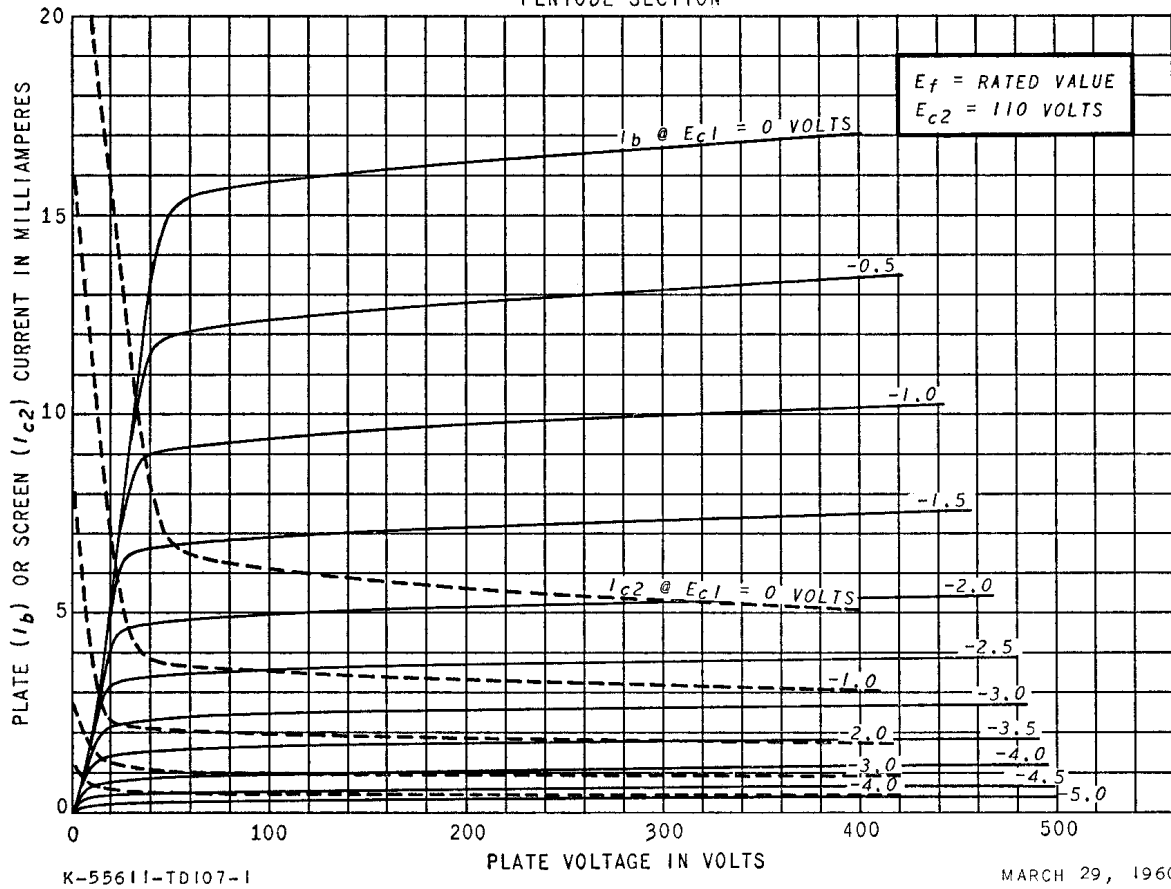

MARCH 29, 1960

AVERAGE PLATE CHARACTERISTICS
 PENTODE SECTION

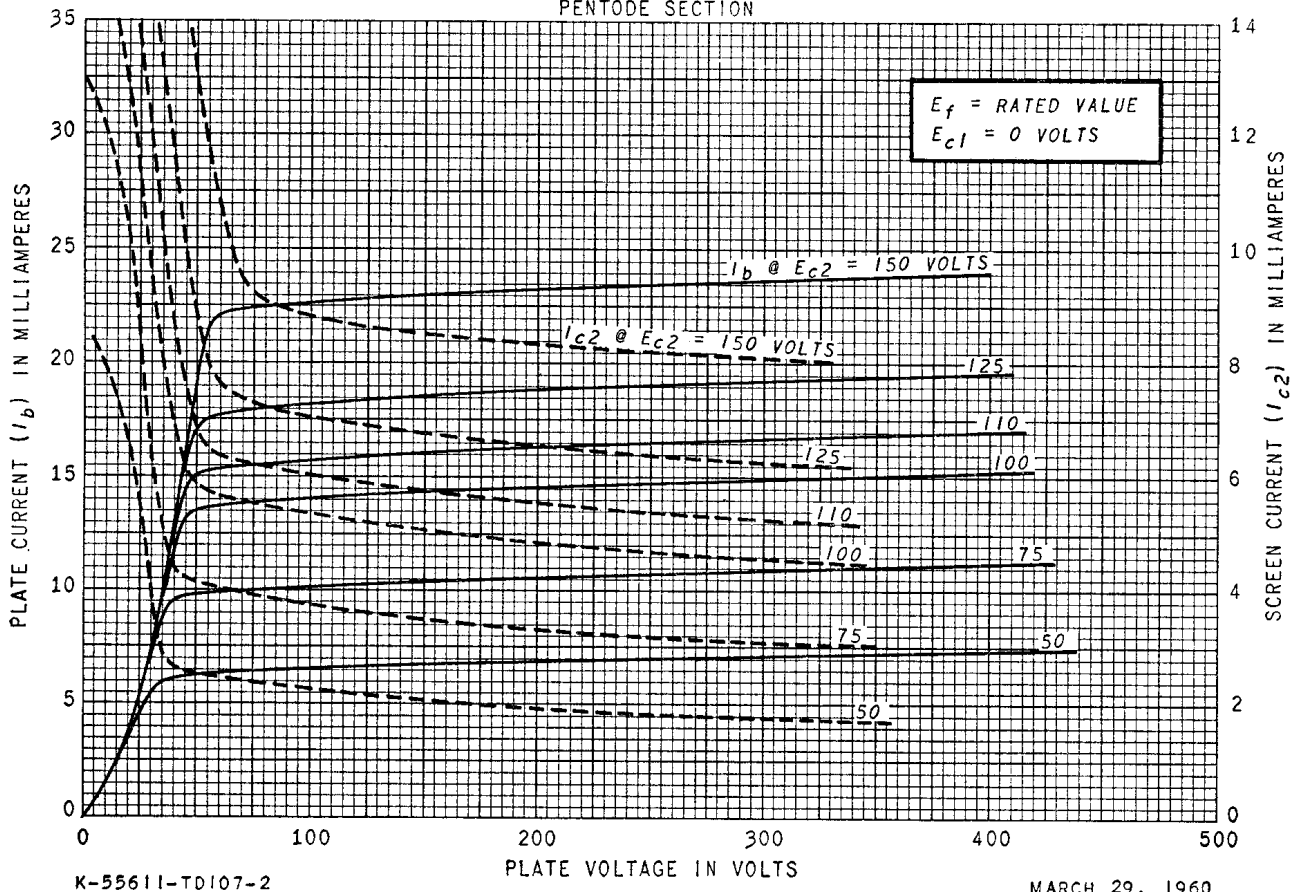

MARCH 29, 1960

AVERAGE TRANSFER CHARACTERISTICS
PENTODE SECTION

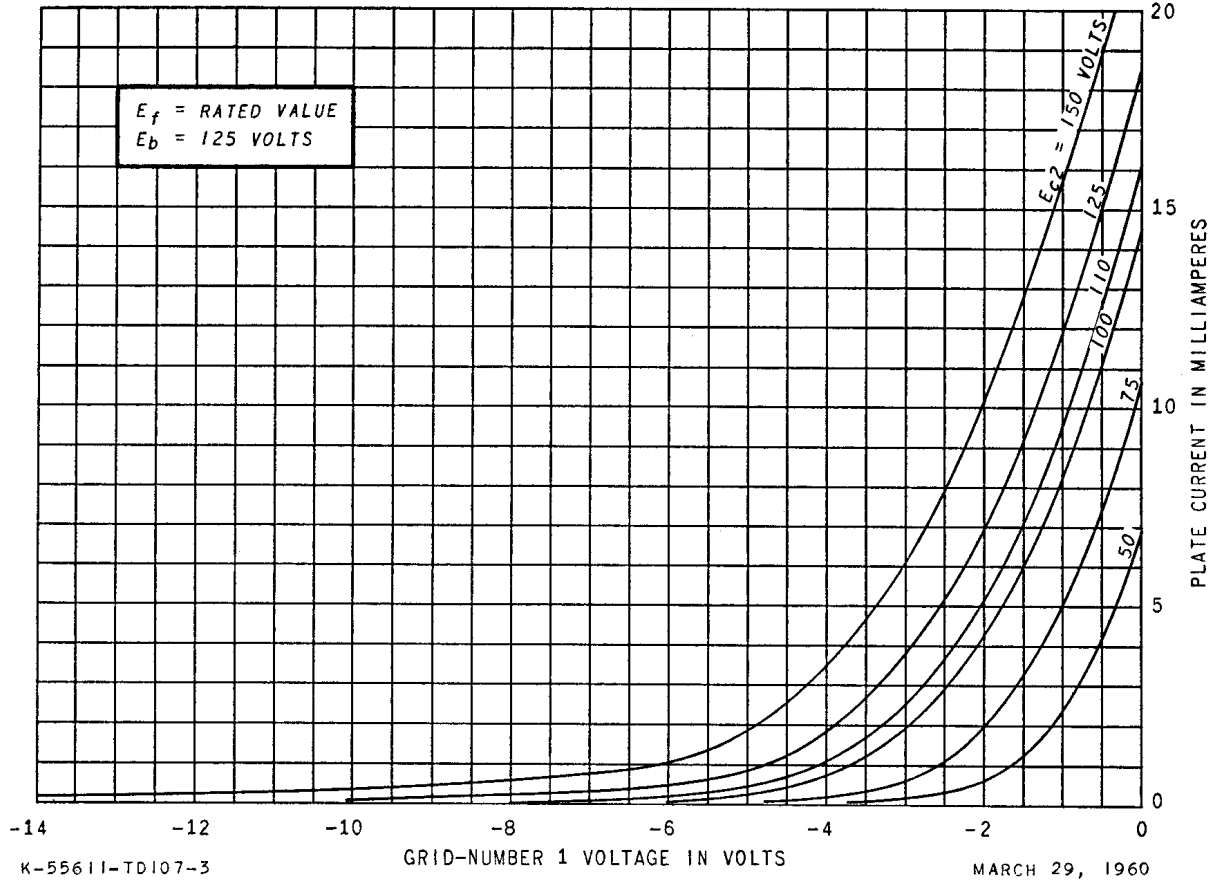

AVERAGE TRANSFER CHARACTERISTICS
PENTODE SECTION

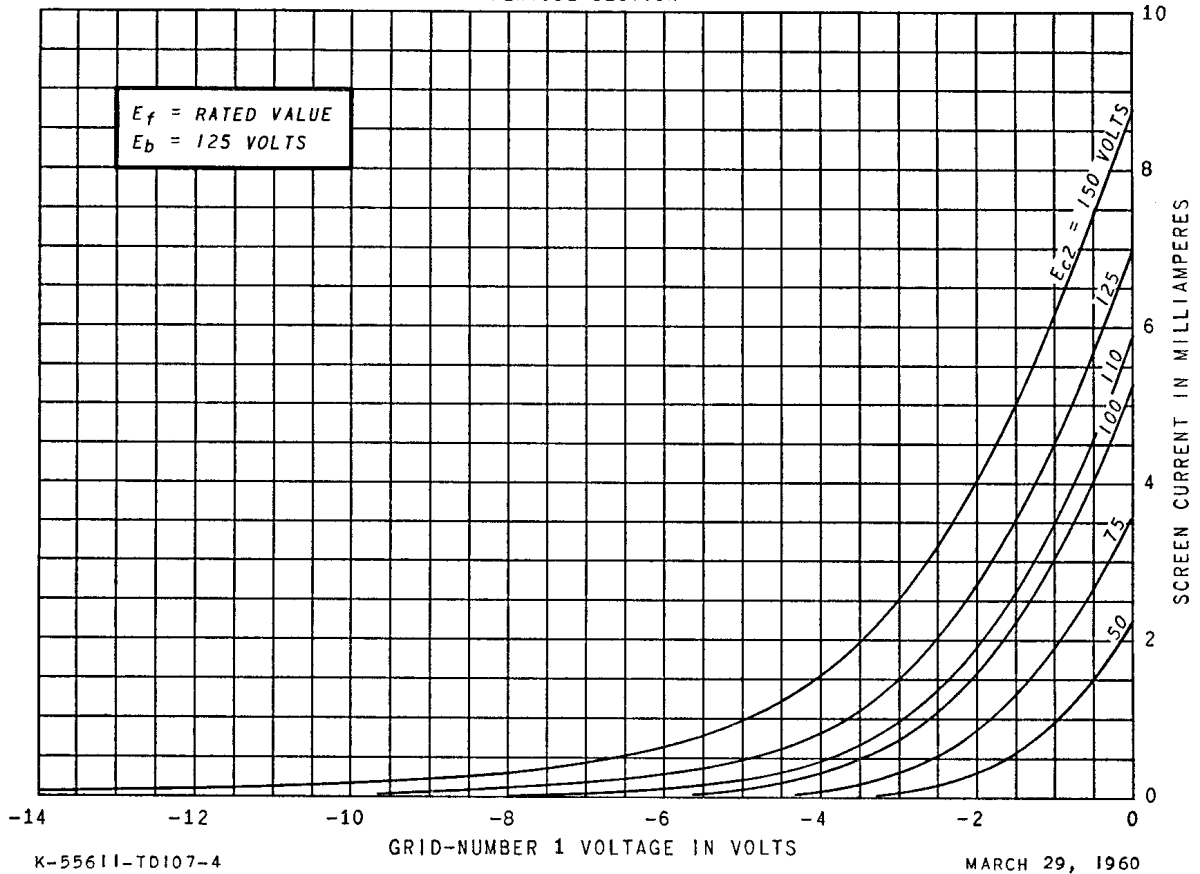

AVERAGE TRANSFER CHARACTERISTICS

PENTODE SECTION

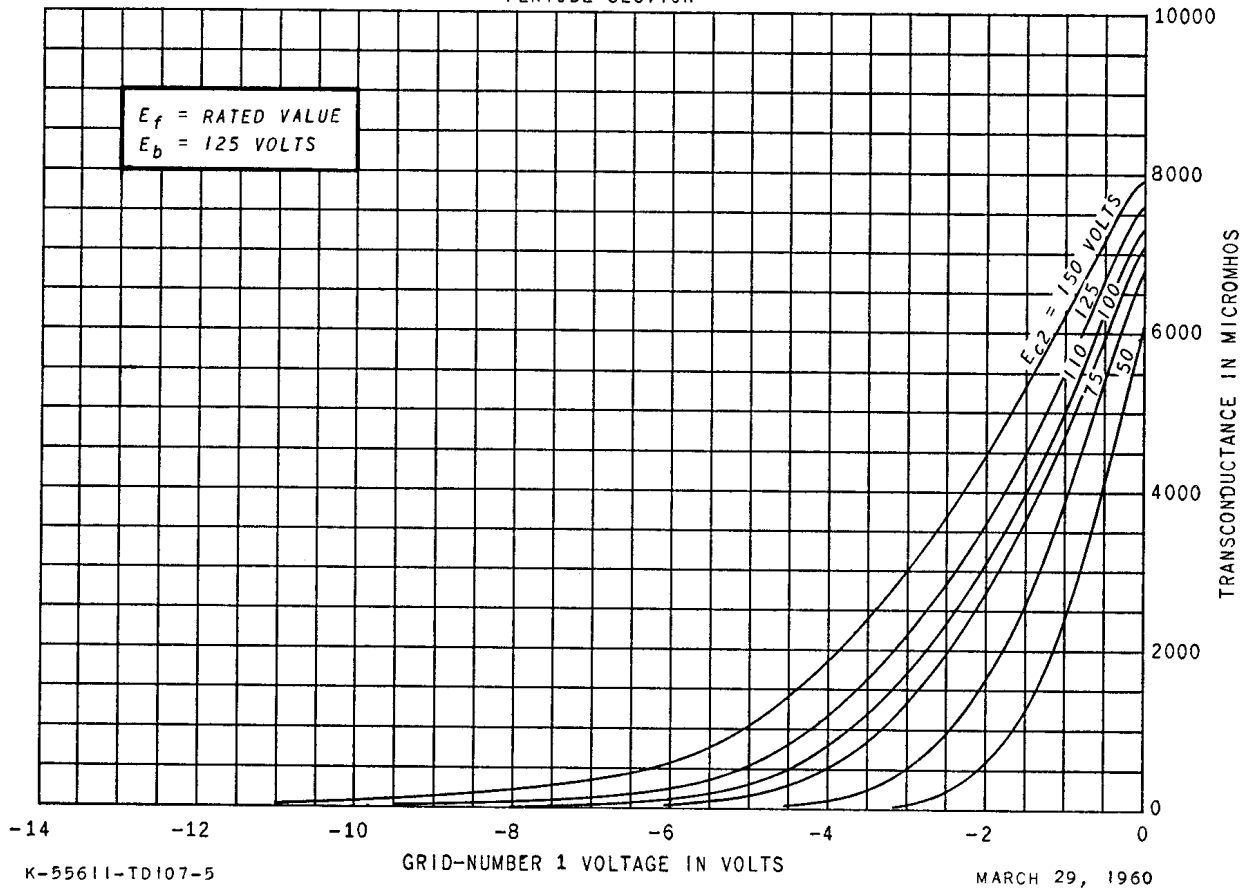

AVERAGE PLATE CHARACTERISTICS

TRIODE SECTION

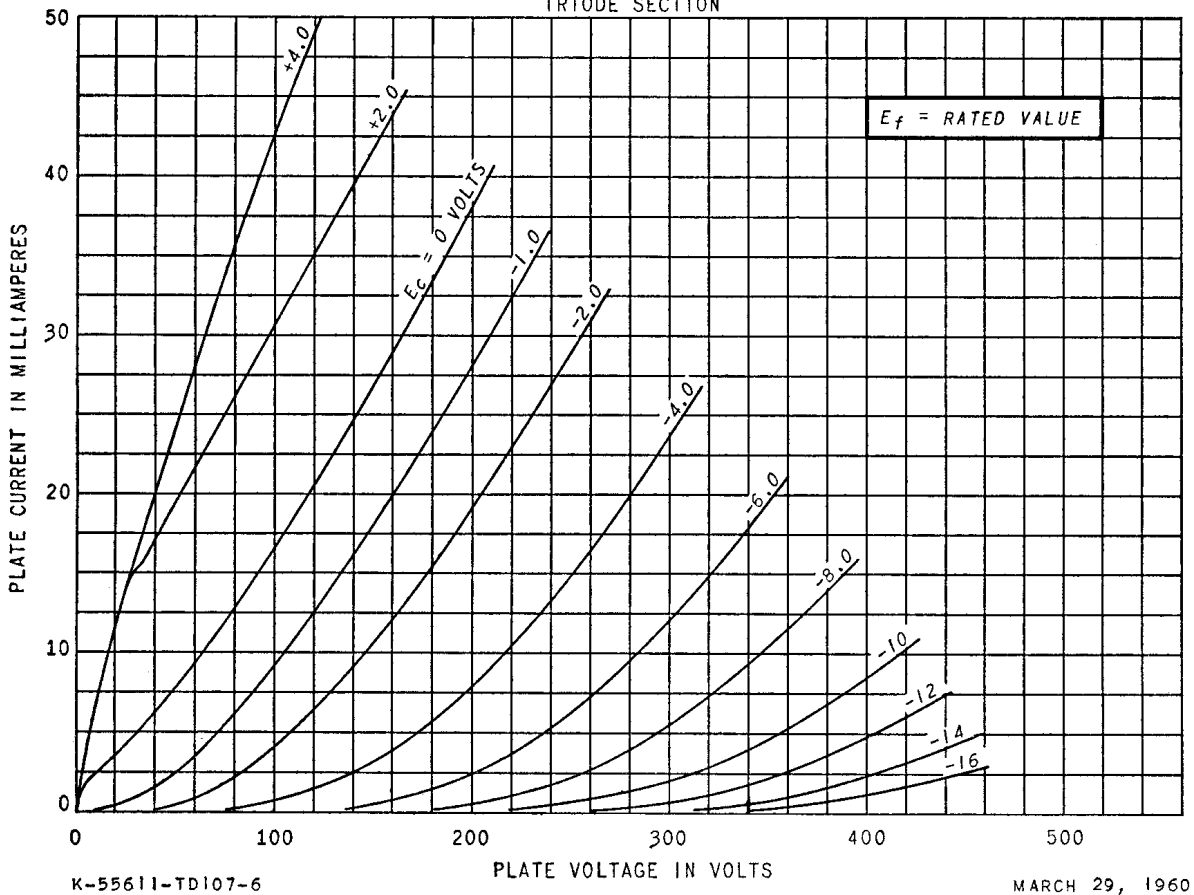

AVERAGE TRANSFER CHARACTERISTICS

TRIODE SECTION

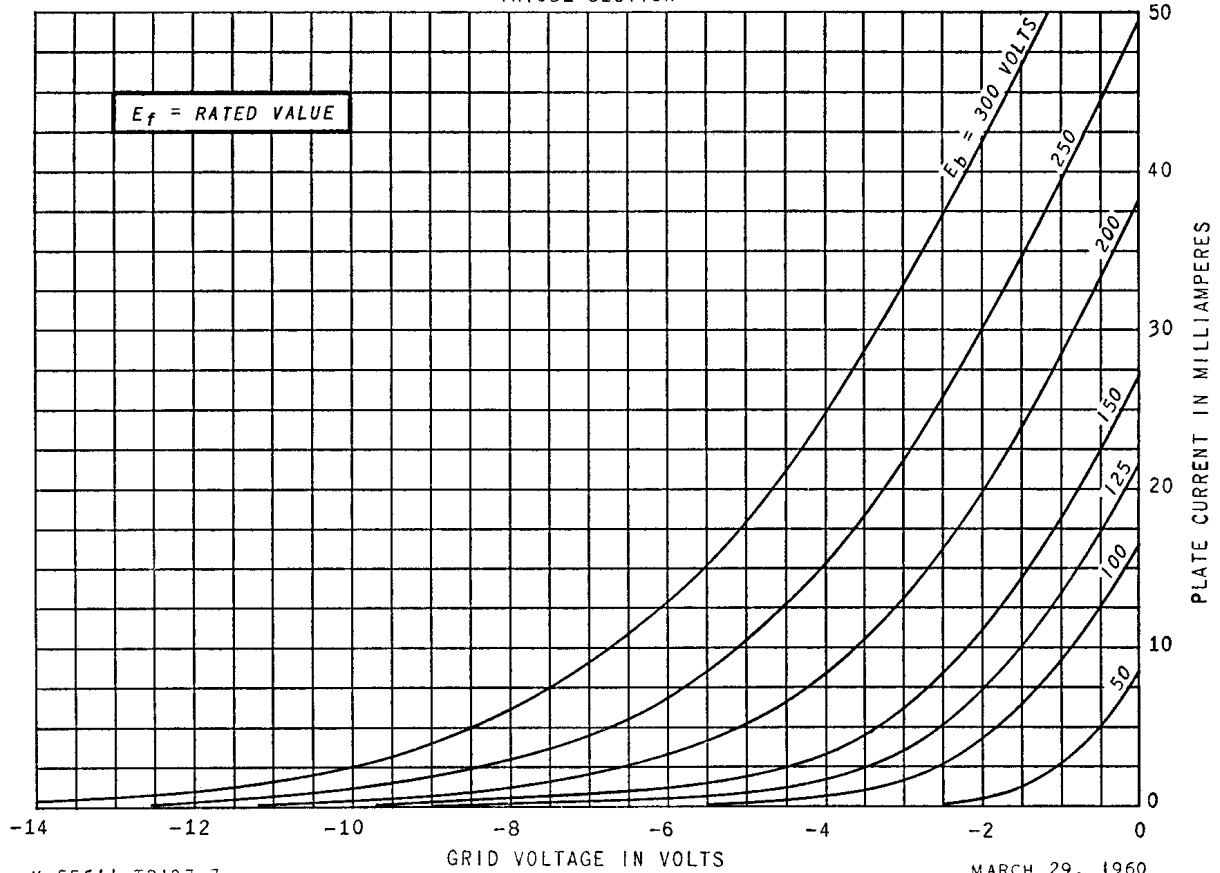

AVERAGE CHARACTERISTICS

TRIODE SECTION

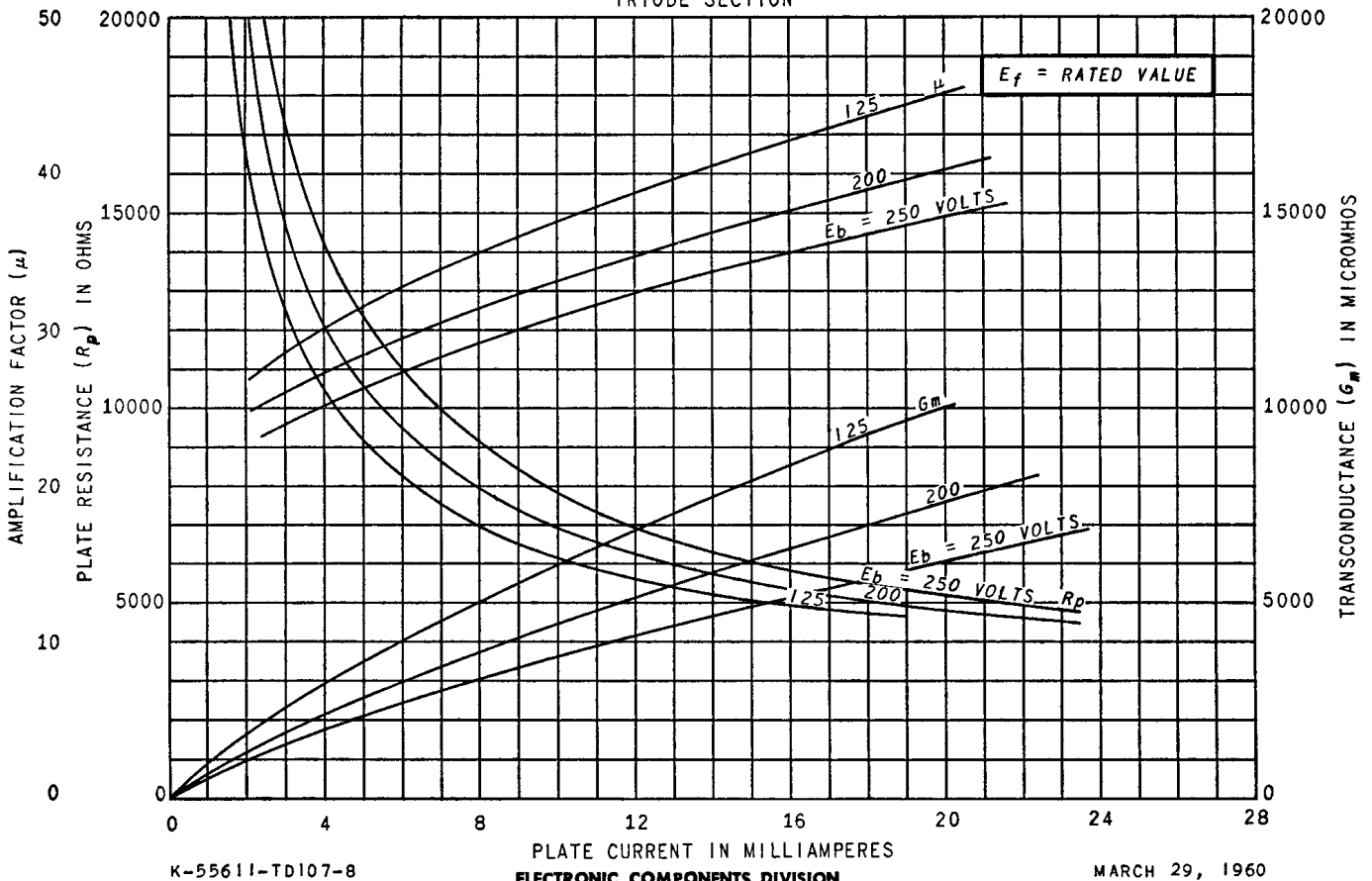

ELECTRONIC COMPONENTS DIVISION

GENERAL ELECTRIC
 Schenectady 5, N. Y.